

SOFIJA PETKOVIĆ, Institute of Archaeology, Belgrade

LATE ROMAN NECROPOLIS OF *ROMULIANA*, AREA SOUTH OF THE FORTIFIED PALACE (RESEARCH 2005–2006)

Abstract. – The purpose of research conducted from 2004–2007 within the scope of international cooperation with the Roman-Germanic Commission of the German Institute of Archaeology in Frankfurt was to investigate the site of Gamzigrad – *Romuliana* in the *extra muros* area, by means of geophysical methods and archaeological probe excavations. Based on a geophysical survey in 2005–2006, revisory excavations were carried out south of the fortified imperial palace, *Felix Romuliana*, whereby the necropolis of *Romuliana*, dating from Late Roman period, was partly explored.

Key words. – *Felix Romuliana* – Gamzigrad, eastern Serbia, Tetrarchy, Late Roman period, necropolis, tomb, Roman army, cruciform fibulae.

The purpose of research within the scope of international cooperation with the Roman-Germanic Commission of the German Institute of Archaeology in Frankfurt (Römisch-Germanische Kommission des Deutsches Archäologisches Instituts, Frankfurt/Main) conducted from 2004–2007,¹ was to investigate the site of Gamzigrad-*Romuliana* in the *extra muros* area by means of geophysical methods (geomagnetic and geo-electric measurements) and probe archaeological excavations.²

Besides data indicating the existence of a ditch along the southern rampart and the southwestern corner of the later fortification of *Romuliana*, in geomagnetic test measurements in September 2004, in the area south of the rampart, the existence of a structure of solid material, the dimensions of which were approximately 4 × 4 m was established. In order to obtain additional information and check the geophysical methods applied, two probes were opened during the excavation campaign in 2005 so as to define the recorded structures (Fig. 1)

The archaeological excavations in 2005 lasted from September 29th till October 16th. Students of archaeology, architecture and geophysics from Serbia and Germany took part in the excavations.³

During the excavations in 2005, in trench 05/1, research was done on a tomb, belonging to the earliest phase of the Late Roman necropolis south of the fortifications of *Romuliana*.

Trench 05/1, of which the dimensions were 6 × 5 m, located in a northwestern – southeastern direction

in relation to the position of the registered object of solid material, was expanded by two meters towards the southeast during excavations so that the said structure could be investigated in its entirety.⁴

Right beneath the surface layer with its vegetation, one could perceive the cultural layer A, of an average

¹ According to the Contract on International Cooperation, on the Serbian side, the participants in the project were the Institute of Archaeology in Belgrade, project manager Sofija Petković, Ph. D., the Faculty of Philosophy in Belgrade, project manager Mihailo Milinković, Ph. D., Maja Živić, M. A, archaeologist, the National Museum in Zaječar and Brana Stojković-Pavelka, architect, the Institute for the Protection of Cultural Monuments of the Republic of Serbia, and on the German side, the Römisch-Germanische Kommission des Deutsches Archäologisches Instituts, in Frankfurt/Main, project manager Gerda Sommer von Bülow, Ph. D., Ulrike Wulf-Rheidt, Ph. D., architect, the Deutsche Archäologische Institut, in Berlin, Ing. Rex Haberland, geodesist, the Brandenburg Technical University in Cottbus and TIm Schüler, Ph. D., geophysicist, University of Jena.

² Sommer von Bülow, Schüler 2009.

³ Participating in the excavations were: Jana Škundrić, Gordana Ćirić and Vuk Kostić, students of archaeology from the Faculty of Philosophy in Belgrade, Bojana Mihaljević, Marijana Masnikosa and Dalibor Pantić, students from the Faculty of Architecture in Belgrade, Mark Opelt, geophysics student from the University of Jena, Birte Geißler, Anne Golke and Daniel Tschernenko, students of archaeology from the University in Rostok, Björn Dußmann and Robert Schmidt, students of architecture from the University in Cottbus.

⁴ Sommer von Bülow, Schüler 2009.

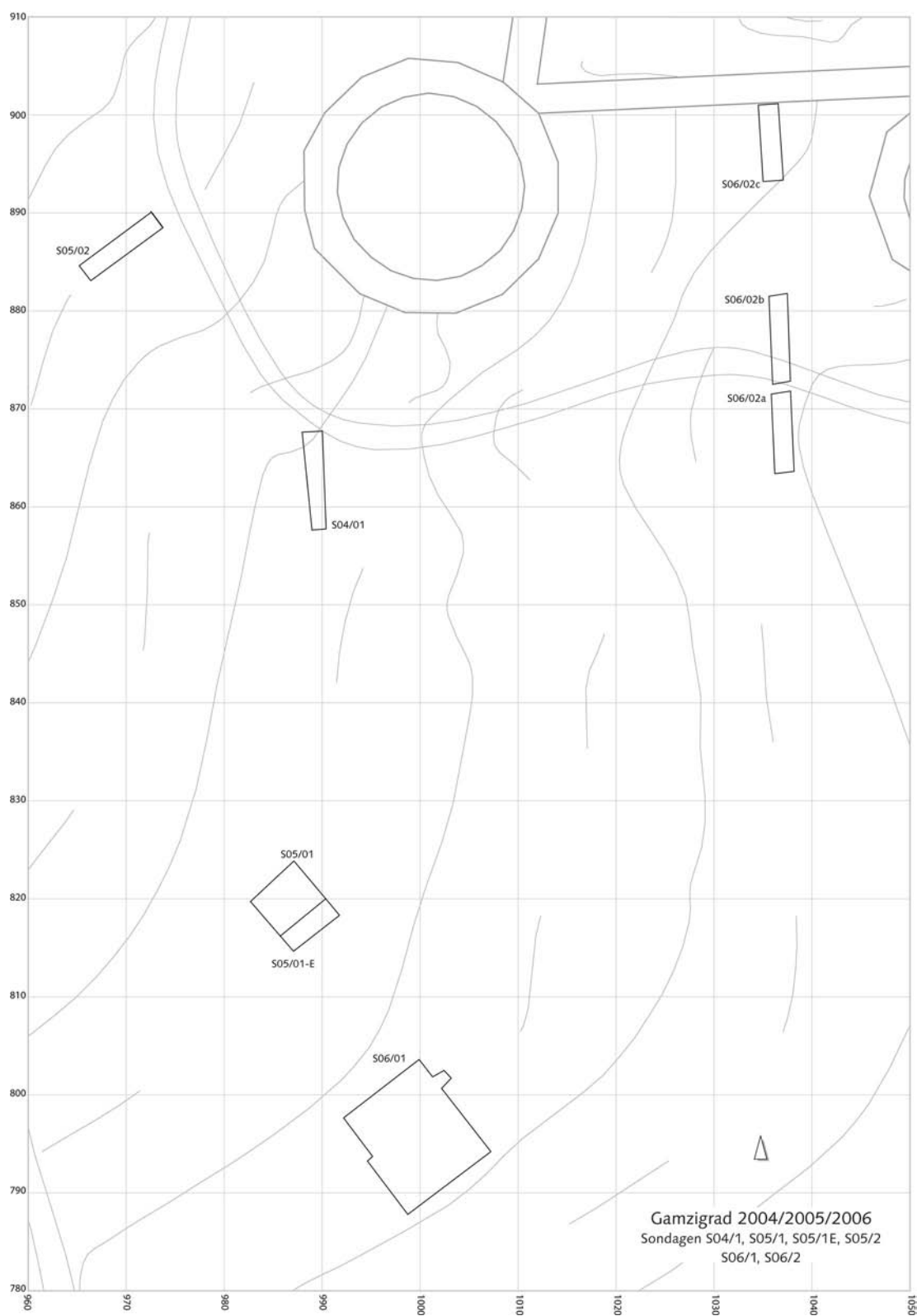

Fig. 1. General plan of test-pit excavations south of the defence wall of Romuliana: test-pits 1/04, 1/05, 2/05, 1/06, 2/06 in relation to the fortification

Сл. 1. Генерални план сондажних ископавања јужно од бегема Ромулијане: сонде 1/04, 1/05, 2/05, 1/06, 2/06 у односу на основу ујврђења



Fig. 2. Tomb in trench 1/05 with the mound of the central grave and the base of the stele, view from the north

Сл. 2. Гробница у сонди 1/05 са хумком централног гроба и базом надгробне сцеле, са севера



Fig. 3. Tomb in trench 1/05 with the mound of the central grave and the base of the stele, view from the northwest

Сл. 3. Гробница у сонди 1/05 са хумком централног гроба и базом надгробне сцеле, са северозапада

depth of about 35 cm⁵, which consisted of dark brown, clayey earth with the remains of small rubble and a small quantity of fragments of vessels from Late Roman times (IV–VI century A.D.), medieval and recent pottery.

This layer covered the recorded object, which had a roughly square base, 3,80 × 3,80 m, the walls of which were of an average width of about 70–80 cm, consisting of broken stones and bricks plastered with mortar. An examination of the interior of the structure led to the conclusion that this was a constructed tomb.

Beneath layer A, a layer of light brown clayey soil appeared, layer B, of an average thickness about 40 cm,⁶ which filled out the tomb outside the central grave. This layer contained a large amount of rubble (tegulae, imbrices, mortar), in which the fragments of ceramic vessels from the III and first half of the IV century A. D. were found (Fig. 48, 6–11).

By removing layer B and emptying the burial pit of the central grave, a layer of yellow-brownish clay that covered the entire interior of the tomb, designated as layer C, was reached.⁷ There were no finds in this layer, and therefore it could be considered to be a culturally sterile layer, subsoil.

A tomb with a square base, preserved in the zone of its foundation⁸, contained, in the middle of the inner, square space (approximate dimensions 2,30 × 2,30 m), a dome-like structure with a circular foundation, made of the pile of broken stones and tegulae covering a mound of earth, the center of which was slightly

shifted towards the northwest. This structure was designated as the central grave. (Figs. 2–3)

The central grave, with a diameter of 1,80 m, consisted of a round stone ring, encircling an oval grave pit (Figs. 4–5), with the upper structure in the form of a mound, of a height of 40 cm⁹, covered by a layer of stone, broken tegulae and imbrices, as well as fragments of red baked ceramic vessels, – pitoi, mortaria and pots (Fig. 48, 1–4). Right beneath the covering of the central grave, a layer of soot and ashes was observed, with the remains of the cremated deceased individual, among which a gold, cruciform fibula was discovered (Figs. 6–7), dated according to type, to the end of the III – beginning of the IV century A. D. (Figs. 8–9).¹⁰

The oval pit of the central grave, inside the round stone ring was filled with greenish-yellow, clayey

⁵ Layer A follows the natural slope of the terrain from the northwest to the southeast, and begins at the elevation points ▼ 194,40 m – ▼ 194, 18 m.

⁶ Layer B, also follows the slope of the terrain and begins at elevation points ▼ 194, 05 m – ▼ 193,90 m, and ends approximately at elevation point ▼ 193, 50 m.

⁷ Layer C appears at elevation point ▼ 193, 50 m.

⁸ The crest of the preserved wall is at elevation points ▼ 194,25 m – ▼ 193,95 m, and the base is at elevation points ▼ 193,75 m – ▼ 193,35 m.

⁹ The crest of the dome-like construction was at elevation point ▼ 194,20 m, and the base was at elevation point ▼ 193,75 m.

¹⁰ Keller 1971, 26, type 1; Pröttel 1988, 347, type 1.

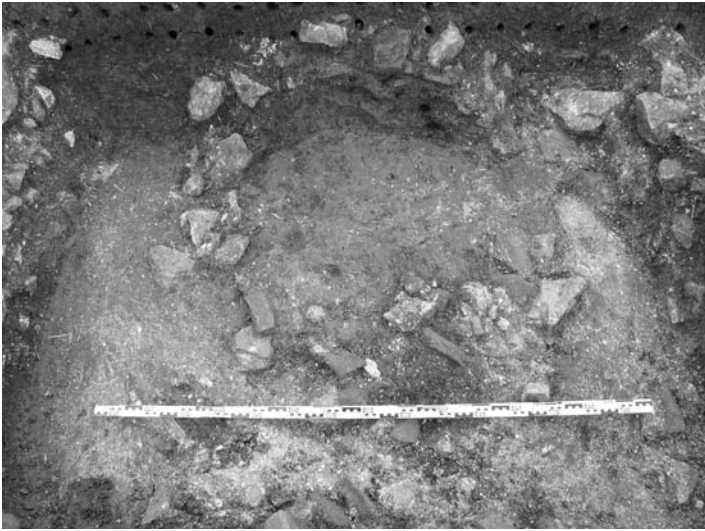

Fig. 4. Central grave in the tomb in trench 1/05, view from the northwest

Сл. 4. Централни гроб у гробници у сонди 1/05, са северозапада

**Romuliana (extra muros) S. 05/1
the Tomb with Central Grave**

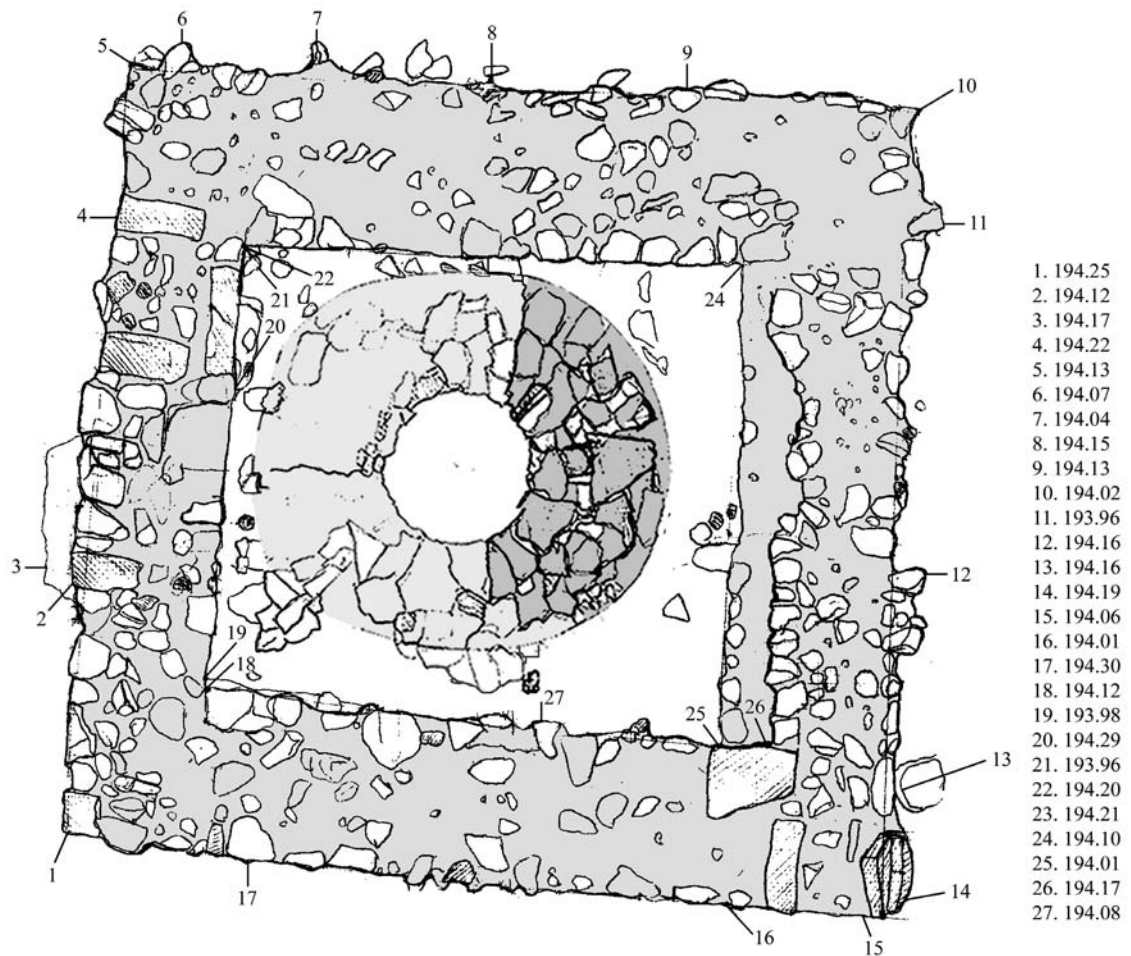

Fig. 5. Plan of the tomb in trench 1/05 with the mound of the central grave

Сл. 5. План гробнице у сонди 1/05 са хумком централног гроба



Fig. 6. Cross section of the mound of the central grave in the tomb in trench 1/05, view from the north

Сл. 6. Пресек хумке централног гроба у гробници у сонди 1/05, са севера



Fig. 7. Cross section of the mound of the central grave in the tomb in trench 1/05 – detail of the find of a gold cruciform fibula in situ, view from the northwest

Сл. 7. Пресек хумке централног гроба у гробници у сонди 1/05 – дејтаљ са налазом златне крстобразне фибуле in situ, са северозапада



Figs. 8–9. A gold cruciform fibula found in the central grave of the tomb in trench 1/05

Слике 8–9. златна крстобразна фибула нађена у централном гробу гробнице у сонди 1/05





Fig. 10. Cross section of the grave pit of the central grave in the tomb in trench 1/05, view from the southeast

Сл. 10. Пресек гробне јаме централног гроба у гробници у сонди 1/05, са југоисточа



Fig. 11. Find of military equipment in situ in the grave pit of the central grave in the tomb in trench 1/05, view from the northwest

Сл. 11. Налаз војне опреме in situ у гробној јами централног гроба у гробници у сонди 1/05, са северозапада

earth, with a very large amount of soot and ashes, as well as cremated human bones to the elevation point ▼ 193,40 m (Fig. 10).

In the pit of the central grave, a fragment of sheet bronze plating was found, as well as five bronze coins belonging to the second half of the III century A. D.,¹¹ and military equipment, buried deep in the layer of greenish-yellow clay (Fig. 11), which consisted of: a long iron sword (*spatha*), with a ritually bended blade, a short dagger with a curved blade (*sica*), the

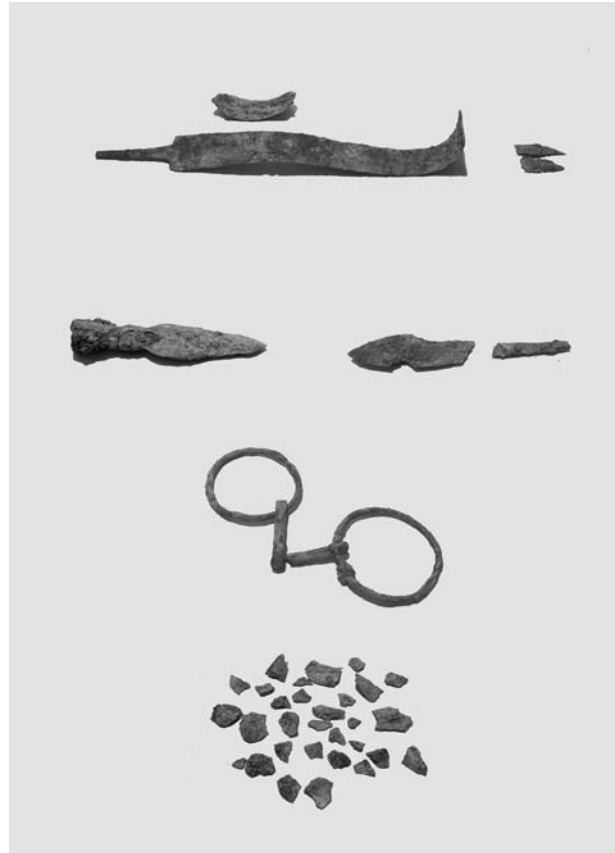

Fig. 12. Find of military equipment from the tomb in trench 1/05

Сл. 12. Налаз војне опреме из гробнице у сонди 1/05

leaf-shaped lance, the fragmented iron *umbo* of a shield, a horse's bit and a large bronze ring, for suspending the sword to a belt (Fig. 12)¹². The parts of the military equipment, except the umbo of the shield, had not been exposed to a high temperature.

Beneath the layer of greenish-yellow clay, the oval grave pit was filled with a light yellow, clayey, sandy soil, interspersed with layers of soot and baked earth to the elevation point ▼ 193,20 m. Also, along its sides, there appeared a layer of soot that was 10–15 cm thick, which perhaps constituted the remains of the

¹¹ The coins were exposed to a high temperature and were very corroded, therefore only two specimens could be identified: one belonging to the emperor Claudius II and one to Probus, respectively (See: Vasić 2009).

¹² Živić 2009.

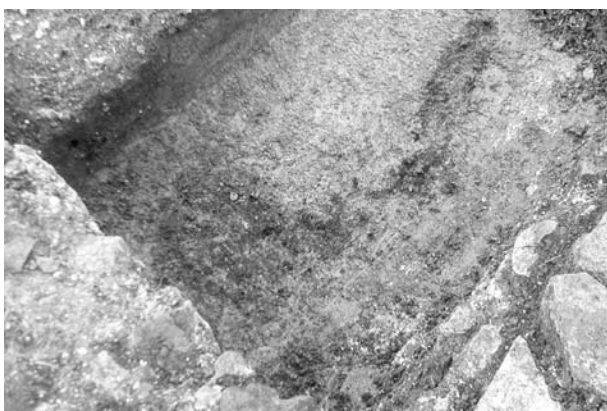

Fig. 13. Grave pit of the central grave with a layer of soot at the sides, tomb in trench 1/05, view from the east

Сл. 13. Гробна јама централног гроба са њрослојком гарежи уз сїѳране, гробница у сонди 1/05, са истїока

carbonised wooden structure of the grave, a kind of shuttering, or traces of the ritual cleansing of the grave by igniting a fire in it prior to the funeral. (Fig. 13) At the bottom of the pit, the remains of carbonised animal bones were observed, while in the grave itself, there were the noticeable osteological remains of a mule and a dog, which belonged to a large breed, without any traces of having been burned.¹³

The analysed remains of carbonised wood from the central grave were mostly of oak, which is the most common tree among the vegetation around Roman *Romuliana*.¹⁴

In the eastern corner of the tomb, we observed parts of the dislocated skeleton of a child, among the tegulae that had caved in. These were the remains of an inhumation in a smaller cyst made of tegulae, in the direction of northwest – southeast, located in the eastern corner of the tomb. Because of the poor state of preservation, it was impossible to establish whether this involved a funeral that was held at relatively the same time as the tomb was built, or a later burial. This grave was damaged by looting or more recently by ploughing the soil. Most probably belonging to the person buried in the cyst in the eastern corner of the tomb, was a pair of small bronze fibulae, of a type with the reversed foot (Fig. 14): one found on the outer side of the southeast, and the other on the outer side of the northeast wall of the tomb. Given the type of fibulae, this grave can be dated from the end of the III to the middle of the V century A. D.¹⁵ This cyst most probably belonged to a necropolis from the last



Fig. 14. A pair of bronze fibulae with reversed feet from a destroyed grave – cyst in trench 1/05

Сл. 14. Пар бронзаних фибула са њосувраћеном сїѳїојом из унишїеног гроба – цистїе у сонди 1/05



Fig. 15. Tomb in trench 1/05, view from the north

Сл. 15. Гробница у сонди 1/05, са севера

¹³ Dimitrijević, Medović 2009.
¹⁴ Dimitrijević, Medović 2009.
¹⁵ Živić 2009.

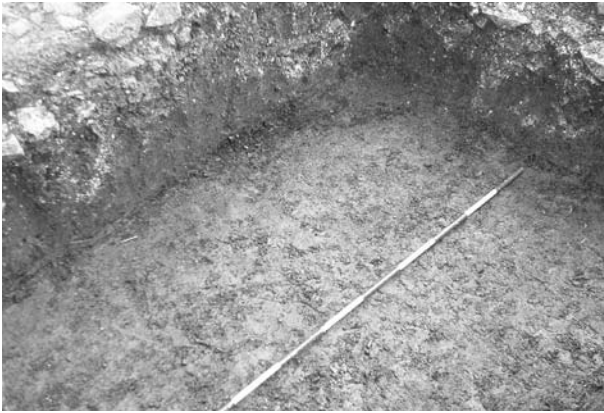

Fig. 16. Inside eastern corner of a tomb with carbonised wood, trench 1/05, view from the west

Сл. 16. Унутрашњи источни угао гробнице са уљенисаним дрвџом, сонда 1/05, са зајага

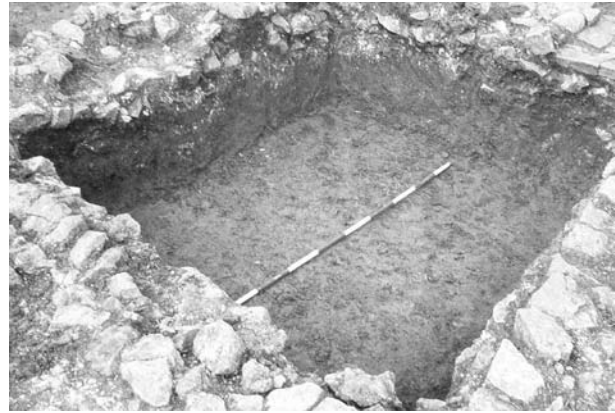

Fig. 17. Interior of tomb in trench 1/05 after the completed excavations with carbonised wood in the eastern corner, view from the east

Сл. 17. Унутрашњост гробнице у сонди 1/05 по завршеним ископавањима са уљенисаним дрвџом у источном углу, са истока



Fig. 18. Walled-up entrance of the tomb in trench 1/05, view from the northwest

Сл. 18. Зазидан улаз у гробницу у сонди 1/05, са северозајага



Fig. 19. Base for a pillar northeast of the entrance to the tomb, trench 1/05, view from the northeast

Сл. 19. База за стуб североисточно од улаза у гробницу, сонда 1/05, са североистока

quarter of the IV – beginning of the V century A. D., partly investigated in the immediate vicinity in trench 06/1.

Next to the inner side of the northeastern wall of the tomb, we established a light layer of soot and a small pit, extending beneath the foundation of the wall, in which burned bones and carbonised wood were found, as well as fragments of items deformed by a high temperature, which most probably originated from the pyre on which the deceased was cremated: two damaged silver platings of a military belt, decorated with engraving and *niello*, with a bronze coin stuck to the

one of them, and the small part of the rim of a silver bowl.¹⁶ Close by, the animal bones were found, as well as the fragment of the rim and bottom of a grey – baked, conically-shaped bowl – lid (Fig. 48, 5). These finds were perhaps the evidence of one more burial of a cremated deceased person within the tomb

¹⁶ Coin, illegible due to the effect of high temperature, fell apart during conservation; and, for the parts of silver items, see: Živić 2009.



Fig. 20. Base for a pillar southwest of the entrance to the tomb, trench 1/05, view from the northeast

Сл. 20. База за стѳуб југозајадно од улаза у гробницу, сонда 1/05, са североистока



Fig. 21. Base for a pillar on the southern corner of the tomb, trench 1/05, view from the northeast

Сл. 21. База за стѳуб на јужном ујлу гробнице, сонда 1/05, са североистока



Fig. 22. The imprint of the base for a pillar in the eastern corner of the tomb, trench 1/05, view from the east

Сл. 22. Отисак база за стѳуб на истоеном ујлу гробнице, сонда 1/05, са истока



Fig. 23. The base of a stele made of tuffaceous breccia in situ beside the northwestern wall of the tomb in trench 1/05, view from the east

Сл. 23. База надгробне стѳеле од туфобрече in situ поред северозајадног зида гробнице у сонди 1/05, са истока

or, of an earlier grave with cremation, which had been destroyed when the tomb was constructed.

The foundation of the tomb was dug in layer B to a depth of 50–60 cm in relation to the level of the crest of the wall.¹⁷ (Fig. 15)

In the eastern corner of the tomb, at the bottom of the northeast wall, the remains of carbonised wood were recorded, most probably the lining of the foundations. (Figs. 16–17)

On the northwest wall of the tomb, an entrance was visible, 90 cm wide, which had been walled up. (Fig. 18) On both sides of the entrance, as well as on

the northern, the western and the southern corners of the tomb, there were square surfaces, paved with tegulae, of dimensions of 80 × 80 cm, most probably the bases of the piers or pillars that supported the upper structure of the tomb. (Figs. 19–21) In the eastern corner, these slabs were missing, but it was recorded that the square surface of mortar was flat, which indicates that a base of the same kind existed in this spot, as well. (Fig. 22)

¹⁷ See Note 8.



Fig. 24. Tomb in trench 1/05 with the base of a stele made of limestone in situ next to the southwestern wall, view from the south

Сл. 24. Гробница у сонди 1/05 са базом надгробне сџеле од кречњака *in situ* уз југозападни зид, са југа



Fig. 25. The base of a stele made of limestone in situ next to the southwestern wall, view from the southwest

Сл. 25. База надгробне сџеле од кречњака *in situ* уз југозападни зид, са југозапада



Fig. 26. The base of a stele made of tuffaceous sandstone, ploughed up in a field next to the southern defence wall of Romuliana

Сл. 26. База надгробне сџеле од џуффејешчара, изорана на њиви уз јужни бегем Ромулијане

The entire structure was very damaged due to farming, i. e. by trench ploughing. The tomb was preserved only in the zone of the foundations, in the section that was embedded in the soil. Based on the surviving remains, it is hard to offer any conclusions about the upper structure of the edifice, which may have had an *edicula*, as shown by the large amount of broken parts of the roof tiles and imbrices found inside it. Also, the tumuloid construction of the central grave perhaps indicates that the upper part of the tomb had a circular shaped base or a central – type polygon.

In the middle of the probe, on the outer side of the northwestern wall of the tomb, in front of the walled up entrance, a stone block of tuffaceous breccia in the cubic shape was excavated, with a rectangular hollow in the middle (Fig. 23). This block is roughly hewn, with uneven sides, except for the flattened side where the hollow was located. The dimensions of the block were 125 cm × 77 cm × 35 cm, and the dimensions of the hollow were 68 cm × 33 cm × 20 cm. One of the longer inner sides of the hollow was slanted. This stone block was dislodged, i.e. overturned on one of the longer, narrower sides towards the northwestern wall of the tomb. The hollow in the square, was filled with small broken stones and yellowish mortar.

In the southern corner of the test-pit, resting against the corner of the narrower side, next to the southwestern wall of the tomb, a block of limestone was found (Figs. 24–25). It is a cube of dimensions

120 × 75 × 30 cm, with a rectangular hollow in the middle, which was 56 × 36 × 20 cm in size. The inside of the hollow on this block was filled with small pieces of stone and brick, embedded in yellowish mortar of poor quality.

Both stone blocks were evidently structural parts of the tomb, most probably the bases of stone funerary monuments.

One should mention that a similarly sized, stone block of greenish-grey tuffaceous sandstone, with a rectangular hollow in the middle, was ploughed up ten years ago, in the field where the tomb was discovered, and placed beside the southern defence wall of *Romuliana* (Fig. 26)

In any case, I believe it involves the tomb of a prominent, high-ranking military officer from the period of the Tetrarchy. Based on the grave finds, we can date the funeral to the very end of the III or beginning of the IV century A. D., and the person, to whom tribute was being paid by being interred right next to the southern rampart of the imperial palace, most probably belonged to the emperor Galerius' closest circle.

The existence of tombs of Galerius' highest dignitaries, members of his closest entourage, in the vicinity of *Romuliana* is also attested by the earlier finds of two, white limestone grave monuments, bearing the image of a heroic horseman in the gable.¹⁸ One of them was erected by *Zelia Iustina*, the wife of *Aurelianus*, who spent twenty years in the Roman army and died at the age of 65 as the *domesticus*, the steward of the imperial palace.¹⁹ (Fig. 27)

Several years ago, ploughing the soil in the vicinity of the fortress of *Romuliana*, a farmer unearthed a gold torque with a pendent, which is now in a private collection in Belgrade. Probably this find also originated from a grave dating from the earliest period of the Late Roman necropolis of *Romuliana*.²⁰ (Fig. 28) This jewelery, according to analogies, can be dated to the second half of the III – first half of the IV century A. D., and more closely to the time of the First and the Second Tetrarchy.²¹

At present, the said tombstones, the tomb investigated in trench 05/1 and the random find of gold jewelry, attest to the earliest phase of the Late Roman necropolis, Phase I, which may be generally dated to the end of the III – first quarter of the IV century A. D..

During the campaign in 2006, the archaeological research done within the scope of international cooperation with the Roman – Germanic Commission

of the German Archaeological Institute in Frankfurt, lasted from August 2nd till September 6th.²²

Based on the results of the geophysical survey by the German team during the 2005 archaeological campaign, south of the fortifications of the imperial palace *Felix Romuliana*, and southeast of the tomb investigated in the previous year in trench 05/1, a structure, the dimensions of which were roughly 8 × 10 m, lying in the direction of southeast – northwest, was registered. The probe excavations in the 2006 campaign began with the research of this structure in trench 06/1, as well as following the ditch recorded along *Romuliana*'s southern defence wall by the geophysical survey and probe excavations in 2004–2005, in trench 06/2.²³

¹⁸ Srejić 1983, 93–95, cat. 40–42; Petrović 1995, 134–135, No. 112.

¹⁹ Mirković 1997, 431–433.

²⁰ I received a photograph of the gold torque and medallion and a report about them from mr. Petar Budželan, a goldsmith from Negotin, son of the late Milan Budželan, a goldsmith from Boljevac, who mediated in the sale of this jewelry. I would like to take this opportunity to thank him. I would also like to thank my colleague Mirko Peković, M. A., Curator of the Archaeological Collection of the Military Museum in Belgrade, who informed me about this find. Unfortunately, the name of the collector in Belgrade is unknown to me.

²¹ For the pendant in the form of a medallion with a frame of twisted wire: Šarkamen-Tomović et al. 2005, 62–63, cat. 5, Fig. 45, Pl. III; *Viminacium* – Popović I. 1991, cat. 8; An unknown site in Serbia and *Viminacium* – Popović, I. 1996, cat. 135–136; *Ratiaria, Durostorum, Augusta Traiana* – Димитрова – Милчева 1980, cat. 311, 321, 322; *Intercisa* – Vágó, Bóna 1976: 193, T. XXIII, T. XXV, 1.

For the twisted torque, see: Поповић И. 2001, 63–64.

²² Participating in the excavations from the Serbian side were: project manager Sofija Petković, M.A., and Aleksandar Kapuran, archaeologist, Institute of Archaeology in Belgrade, project manager Mihailo Milinković, Ph. D., Živko Mikić Ph.D. Miroslav Vujović, Ph.D., Faculty of Philosophy in Belgrade, Maja Živić, M. A., National Museum in Zaječar, Slobodan Radovanović, archaeologist, Aleksandar Medović, paleobotanist, the Museum of Vojvodina in Novi Sad, Jana Škundrić, Branko Aleksić and Vuk Kostić, students of archaeology from the Faculty of Philosophy in Belgrade, Anđelija Pavlović, student of the Faculty of Architecture in Belgrade and Nikola Ivanković, student of the Faculty of Architecture in Niš, and from the German side, Gerda Sommer von Bülow, Ph. D., project manager from the the Römisch-Germanische Kommission des Deutsches Archäologisches Instituts, in Frankfurt/Main, Claudia Mariategui, Birte Geißler, Anne Golke and Daniel Tschernenko, students of archaeology from the University in Rostok.

²³ Sommer von Bülow, Schüler 2009.



Fig. 27. Stele of Aurelianus – domesticus – found near the western gate of Romuliana

Сл. 27. Нагробна сџела Aurelianus – domesticus – а нађена у близини зајадне капије Ромулијане



Fig. 28. Gold jewelry found near the fortress of Romuliana

Сл. 28. Златиан накити нађен у близини ујврђења Ромулијане

In the course of the excavations of the object in test-pit 06/1 and the ditch in trench 06/2, graves containing inhumed or cremated human remains, belonging to the later phases of the Late Roman necropolis, located south of the fortifications of *Romuliana*, were recorded.

In trench 06/1 it was established that in this area, a necropolis had existed, in the Late Roman period. In the interior and outside the excavated structure, eight graves were examined, some of which were partly damaged by the construction and reconstruction of the said object, and most probably by looting during Late Roman times and, more recently, by trench ploughing in this area. (Fig. 29)

In the northern part of trench 06/1, in the inside of the object, we found grave 1/06, a cyst of tegulae, the base of which was at elevation point ▼192,89 m, lying in the direction of west – east, digressing slightly towards the north, which had been destroyed by the

construction of a partition of tegulae joined together by means of yellow clay (wall 7). (Fig. 30)

On the preserved bottom of the cyst, fragments of the skull and other bones of a child's dislocated skeleton were discovered. Apart from osteological remains, the grave was found to contain the following items (Fig. 31)²⁴: a silver *bulla*, a pendent – amulet made of a sea shell, the fragment of a small varnished ceramic bowl and two bronze bracelets of open – type, one band – like, with widening ends, engraved with decorative vertical and horizontal lines, and the other, with a circular cross section and tapering ends.

In the northern part of trench 06/1, south of the damaged wall 6, grave 2/06 was also discovered, a cyst of tegulae, lying in the direction of southwest – northeast. The grave contained the fragmented skull

²⁴ Živić 2009.

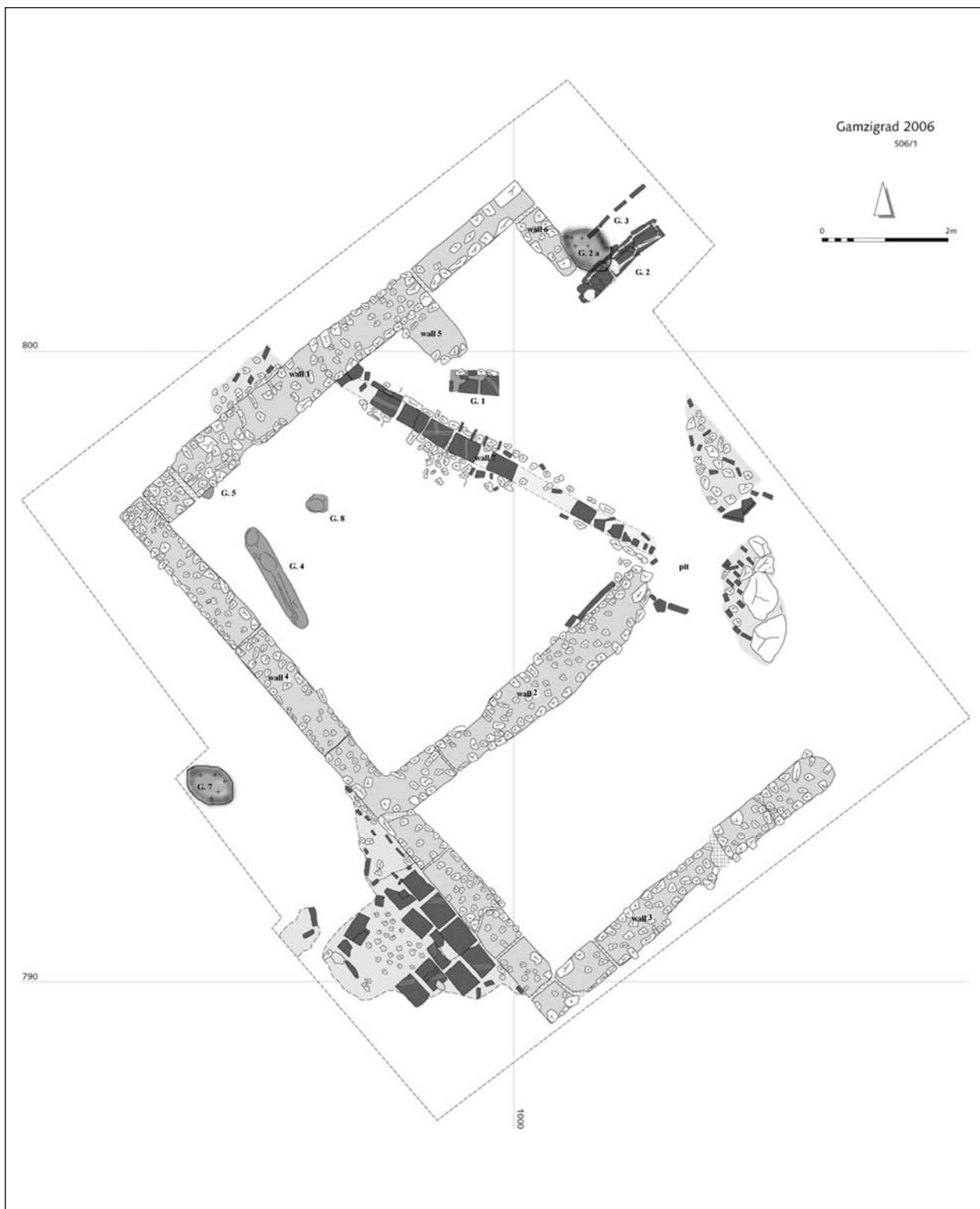

Fig. 29. Plan of the construction and graves in test-pit 1/06

Сл. 29. План зграђевине и гробова у сонди 1/06



Fig. 30. Grave 1/06, view from the northeast

Сл. 30. Гроб 1/06 са северосијугока

of a child and, at the preserved bottom of the cyst, the very poorly preserved skeleton of an adult male individual, laid out on his back, with his arms bent at the elbows and hands crossed over the pelvis. The skull was discovered at elevation point ▼192,66 m (Fig. 32).

The sides of the cyst and the covering of tegulae had collapsed. The lid of the grave was perhaps destroyed by looting in the period of Late Antiquity, but the bones of the deceased had not been moved. The upper part of the cyst may also have been destroyed in more recent times, by trench ploughing. The grave was recorded to contain the following finds²⁵: the debris in the cyst contained the fragments of the iron plating and handle of a ceramic cup, backed light grey in colour, with a partly polished outer surface, and resting on the pelvis of the deceased, a bronze belt-buckle, with a rectangularly shaped plating, the loop of the buckle in the shape of a letter B, and the buckle-pin with a profiled tip, extending over the buckle frame.

During the excavation of grave 2/06, in the extension of trench 06/1 towards the northeast, above the cyst, at elevation point ▼193,02 m, a grave pit, containing the carbonised remains of human bones, ashes and soot was recorded, most probably a later grave with a cremated individual, grave 2 a/06 (Fig. 29). There were no finds in the grave. The grave pit was partly destroyed when the soil was tilled, or rather trench ploughed. It is possible that when digging the



Fig. 31. Jewelry from grave 1/06

Сл. 31. Накитиј из гроба 1/06

pit of this grave, wall 6 of the structure was damaged, as well as the upper part of the cyst of grave 2/06.

Also in the aforesaid extension of the trench, northeast of the previous grave, another ruined cyst of tegulae was discovered, of grave 3/06. The grave lay in the direction of southwest – northeast (Fig. 33). The sides of the cyst and the lid of tegulae had collapsed, and on the preserved bottom of the grave, fragments of the bones of a female individual were discovered, among which there were two Roman bronze coins from the middle of the IV century A.D., perforated so they could be attached to a chain²⁶ and a bead of black glass paste with two longitudinal holes that had been part of a necklace or bracelet.²⁷ Grave 3/06, with the base at elevation point ▼193,13 m, was most probably damaged by looting in the Late Roman period, given the dislocated bones of the skeleton and the scanty remains of the grave finds.

In the northwestern part of trench 06/1, beside the northwestern wall of the object, made of broken stone bound by mortar (wall 1), the skull of a skeleton was discovered at elevation point ▼192,81 m, grave 4/06 (Fig. 34). This was a dug grave pit, lying in the direction of northwest – southeast, in which a deceased male had been interred, laid out on his back, the arms

²⁵ Živić 2009.

²⁶ Vasić 2009.

²⁷ Živić 2009.



Fig. 32. Grave 2/06, view from the southwest
 Сл. 32. Гроб 2/06, са јуџоозајага



Fig. 33. Grave 3/06, view from the southwest
 Сл. 33. Гроб 3/06, са јуџоозајага

bent at the elbow and hands folded over the pelvis (Fig. 35). Two Roman bronze coins from the middle of the IV century A.D. were found in the region of the skeleton's right femur.²⁸

In the western part of the trench 06/1, beneath the northwestern wall of the object (wall 1), a dug grave 5/06, lying in the direction of southwest – northeast, was found to contain a skull at elevation point ▼192,82 m. In order to explore the grave entirely, part of the object's northwestern wall was removed (wall 1). In this grave a young female individual was buried, laid out on her back, the arms bent at the elbows and hands folded over the area of the stomach (Figs. 36–37). On each forearm, there was a bronze, open – type bracelet, the ends of which were shaped like snake heads (Fig. 38) and, in the area beneath the legs several fragments of carbonised vessels were found.

Outside the object, on the outer side of the southwest wall (wall 4), along the south-western profile of trench 06/1, at elevation point ▼192,58 m, the remains of the partly cremated fragments of a skull and other bones were established in grave 7/06 (Fig. 29). This was most probably a child's burial and there were no finds in the grave. It is not clear from which level grave 7/06 was dug, because it was not possible to notice the pit of the grave.

Inside the object, in the western part of trench 06/1, northeast of grave 4/06 and southeast of grave 5/06, grave 8/06, which had mostly been destroyed was found. The damaged skull of the deceased was at elevation point ▼192,85 m as well as several poorly preserved and dislocated bones: the right clavicle, several pieces of ribs and fragments of the hand –

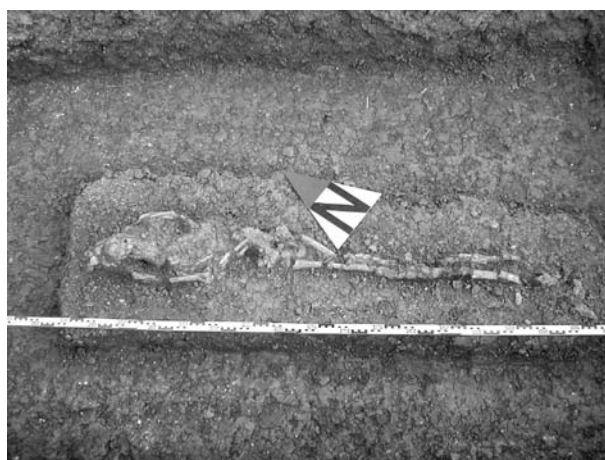

Fig. 34. Grave 4/06, view from the southwest
 Сл. 34. Гроб 4/06, са јуџоозајага

bones. Attached to the right side of the skull was an iron, very corroded arrow point. The grave pit was dug in the direction of southwest – northeast. However, apart from the skull and the aforesaid bones, most probably of an adult individual, the skeleton was missing, that is, the grave was mostly destroyed (Fig. 40). It could be assumed that the damage to grave 8/06 was caused due to the construction of an early Byzantine structure.

Trench 06/2 was positioned in the direction of north – south, over the ditch, recorded in the geophysical

²⁸ Vasić 2009.

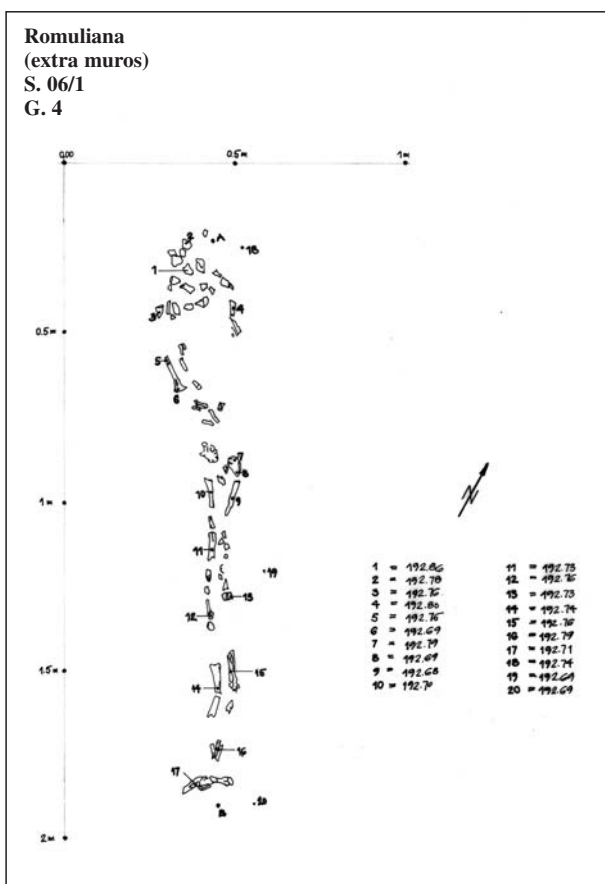

Fig. 35. Drawing of grave 4/06

Сл. 35. Црпљеж зроба 4/06

survey and probe excavations (trench 04/1 and trench 05/2) during the 2004–2005 campaign along the defence wall of the later fortification of *Romuliana*.

Since part of the said ditch was explored in trench 06/2, the probe was prolonged in a northward direction to the southern defence wall of *Romuliana* in order to reveal its possible connection with the fortress.²⁹ On that occasion, part of a skeleton was unearthed right beside the foundation zone of the southern defence wall, in dug grave, lying in the direction of west – east. To enable a full investigation of the said grave, designated as grave 6/06, trench 2/06 was extended eastwards along the southern defence wall of the fortress. This was a dug grave pit, in which the deceased was interred laid out on his back, the arms bent at the elbows and hands crossed over, resting on the pelvis. The northern side of the grave was part of the foundation of the southern defence wall belonging to the later fortification of *Romuliana*. (Figs. 41–42)

A very well preserved skeleton was discovered, belonging to an adult male individual, (Figs. 42–43)

along with whom grave goods were found beside his left lower leg³⁰: a bronze belt-buckle, with a rectangular plating and a rectangular frame with a pin that exceeded the frame, and beside it six Roman bronze coins from the Valentinian period,³¹ an iron fire – steel with two Roman bronze coins joined together and a flint, most probably carried in a leather or linen pouch that had rotted away.

When lifting the skull of the skeleton, which lay at the right shoulder of the deceased, a gold-plated bronze cruciform fibula was found (Fig. 45). Its bow was longitudinally decorated in niello technique, with alternating motifs of a rhombus and a circle inscribed with a cross, and rectangular metopes with male *en face* portraits, at the beginning and the end (Fig. 46). The rectangular foot of the fibula was made

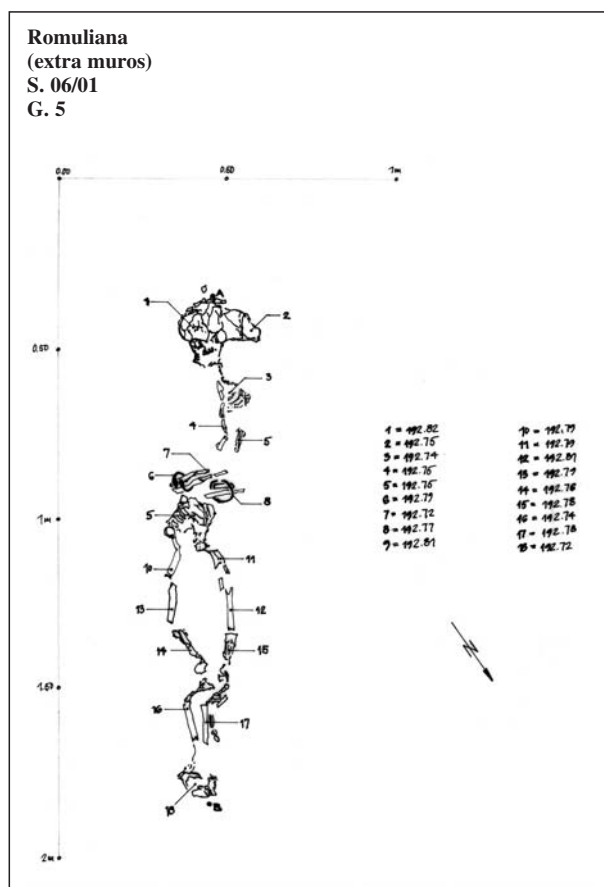

Fig. 36. Drawing of grave 5/06

Сл. 36. Црпљеж зроба 5/06

²⁹ Sommer von Bülow, Schüler 2009.

³⁰ Živić 2009.

³¹ The latest coin belongs to the coinage of the emperor Valens from the period 375–378 AD (See: Vasić 2009)

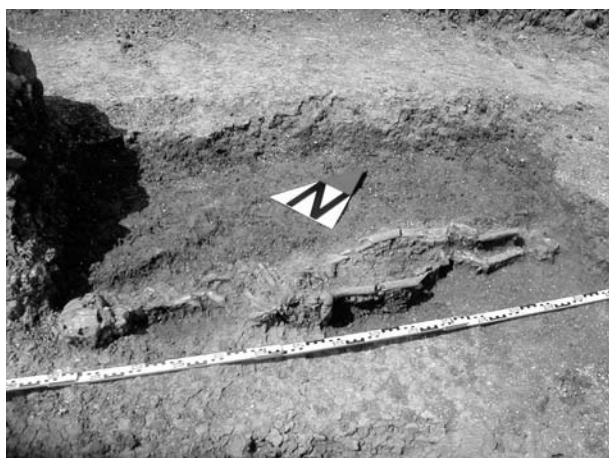

Fig. 37. Grave 5/06, view from the southeast
 Сл. 37. Гроб 5/06, са југоистіока



Fig. 38. Bronze bracelet in situ in grave 5/06, detail
 Сл. 38. Бронзана наруквџице in situ
 у гробу 5/06, деџиљ

of silver sheet, the sides of which were profiled with a pelti motif, decorated in niello technique with a fish-bone motif and with another rectangular metope with a male *en face* portrait (Fig. 47). The fibula had an iron pin, on which there were preserved shreds of a white, woollen, military cloak (*paludamentum*).

The typological characteristics of the cruciform fibula indicates that it was produced at the end of the IV or beginning of the V century, when profiling the edges of the foot with the pelti motif appeared on this type. If we agree with the idea that the medallions on cruciform gold-plated fibulae contained imperial portraits³², coupled with the fact that three emperors were depicted, there are two possible alternatives for determining the date when it was produced: during the rule of Valentinianus I, Valens and Gratianus (367–375 A.D.) or during the rule of Valens, Gratianus and Valentinianus II (375–378 A.D.). Given that the latest finds of coins from the pouch buried in grave 6/06 belonged to the coinage of the emperor Valens,³³ the fibula was most probably presented as a gift in the time of the Valentinian dynasty. The occasion may have been the promotion of a *Caesar* to the title *Augustus*: Gratianus in 367 A.D. or Valentinianus II in 375 A.D. In addition, the bronze buckle from the grave is dated to the time of the Valentinian dynasty.³⁴

The burial of the high-ranking, Roman army officer beside the southern defence wall of *Romuliana* can be linked to an incursion by the barbarians, the Goths, the Alani or the Huns, in the territory of the Roman provinces of *Dacia Ripensis* and *Moesia Prima* after the battle of Hadrianopolis, in 378–381 A.D.³⁵

The grave of the warrior at the foot of the southern defence wall of the fortification perhaps belonged to the commander of the military crew of *Romuliana* in the Late Roman period, considering his high rank, as testified by the fibula with which he was buried. The position of the grave has a symbolic character: the interred officer, fallen in the defence of the fortress, remained posthumously to defend forever the walls of *Romuliana*.

Part of the funerary monument dedicated to Gaudentius »ac positi(o)ne decorus«³⁶ is testimony of the prominent inhabitants of Christian *Romuliana* in the period of Late Antiquity, at the end of the IV and in the first half of the V century. The person interred in grave 6/06, beside the southern defence wall, also belonged to the elite class of *Romuliana* at that time.

The section of the Late Roman necropolis, examined in trenches 06/1 and 06/2, with the inhumed deceased, on the basis of the burial ritual and grave finds, can generally be dated to the last quarter of the IV and the beginning of the V century A.D.³⁷

³² Laur – Belaart 1959; Иванов 1972; Јовановић 1975.

³³ The coins can be treated as a collective find, with the latest specimen dating from 375–378 (See: Vasić 2009).

³⁴ Živić 2009.

³⁵ Burns 1994, 69–72.

³⁶ Лаловић 1983, 165, cat. 335; Petrović 1995, 135, No. 113.

³⁷ For burial rituals and types of grave structures, see: Petković, Ružić 2004, 129–141, and for finds in the catalogue (Živić 2009).

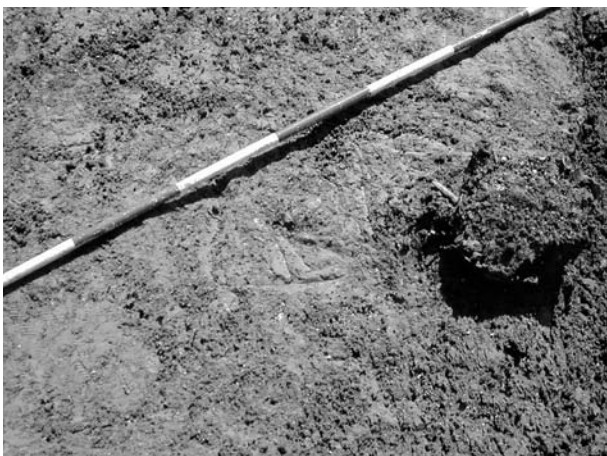

Fig. 39. Grave 8/06, view from the south

Сл. 39. Грoб 8/06, ca јyзa

In earlier research work in *Romuliana*, the burials that may have taken place from the end of the IV to the middle of the V century A.D. were recorded. Four graves, with a construction of tiles, attributed to this chronological span, were discovered on the bank of Dragan's brook (Draganov potok), northeast of the fortified palace.³⁸ Although three graves were mostly in ruins, one was entirely preserved. This grave, which lay in the direction of west – east, with the upper structure of tegulae placed so as to form a gabled roof, had contained an adult male laid out on his back, arms bent, with his right hand resting on his stomach and his left, resting on his chest. Near his lower leg, we found a bronze military belt-buckle, with a rectangular plating and a buckle frame in the shape of the letter B, with its iron pin extending over the frame of the buckle. Stuck to the inside of the buckle plating was a bronze coin, belonging to the emperor Valentinianus I.

This rather large Late Roman necropolis of *Romuliana* from the last quarter of the IV and first half of the V century A.D, stretching south and northeast of the fortress, the size and boundaries of which are still unknown, testifies to the intense life in this site in the said period.

It is interesting to note that a part of this necropolis, in trench 06/1, was interpolated between the later, early Byzantine phase of the explored object from the VI century A.D, and the remains of the earlier phase of the Roman structure from the second half of the III – beginning of the IV century A.D.

The Late Roman graves in the interior of the fortress are an unusual phenomenon in *Romuliana*.

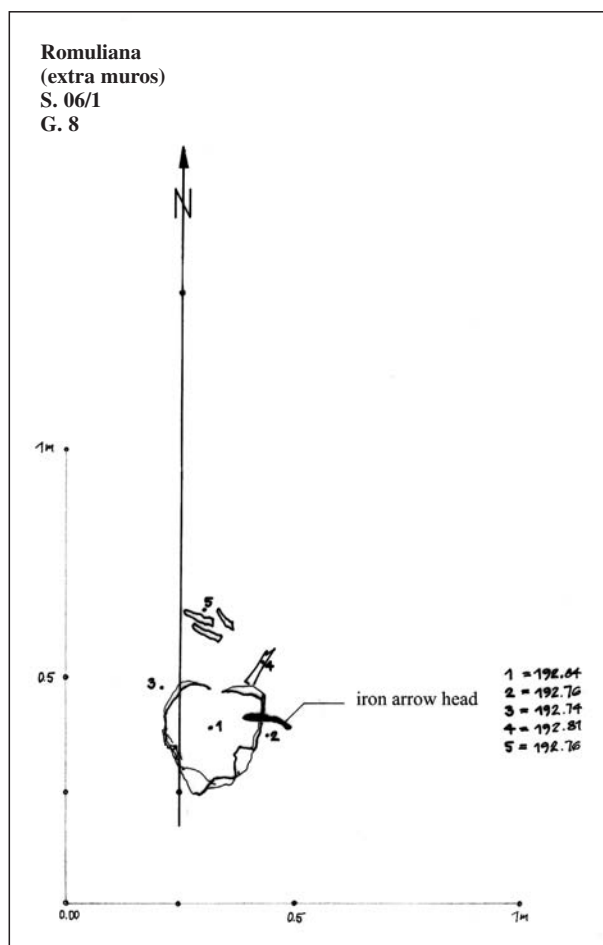

Fig. 40. Drawing of grave 8/06

Сл. 40. Црџеж грoба 8/06

Two graves, cysts made of tegulae, one of a child and the other of an adult female, were found in the central part of the southern tower at the western gate of the later fortification of *Romuliana* (Tower 19), interred in the layer dating from the third quarter of the V century A.D.³⁹ The graves were in the direction of west – east, and the sides of the cysts were made of tegulae laid in reverse, to the bottom, while the lid was made of horizontally placed tiles. The child's grave was looted, whereas grave goods were found in the woman's grave: left of the skull was an antler comb with two rows of teeth and in the region of the breast, a whorl made of the same material.

³⁸ Јанковић 1983, 105–106, Pic. 83.

³⁹ Petković 2006, 38–39, Fig. 2, Pl. II, 3–4.

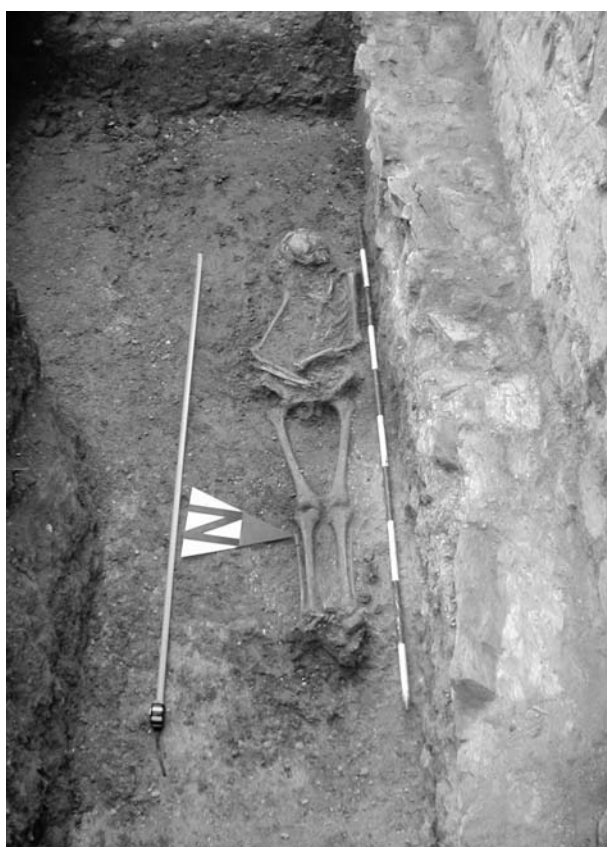

Fig. 41. Grave 6/06, view from the east

Сл. 41. Грoб 6/06, са исуoка

Graves *intra muros* were also recorded in the earlier research in Gamzigrad, in the triclinium of palace I, in the south-western part of the fortress, in the building with mosaics, »Romula's triclinium« and in the sector of Galerius' baths.⁴⁰ This group of graves can be dated to the second half or, more exactly, to the third quarter of the V century, when *Romuliana*, after the invasion by the Huns in 441 A.D, functioned as a kind of *refugium* for the remaining population from the neighbourhood.⁴¹

The cremation graves in the Late Roman necropolis of *Romuliana*, grave 2a/06 and grave 7/06 present a particular problem. For the first burial with a cremation, given the stratigraphy of the cultural layers in trench 06/1, we may assume that it belonged to the early Byzantine period. In the event that the construction of grave 2a/06 damaged wall 6 of the building, in other words, if graves 2/06 and 3/06 were older than the said structure, this cremated person may have belonged to the period of the second half of the VI – beginning of the VII century A.D.⁴² Certainly, grave 2a/06 originated from a later time than graves

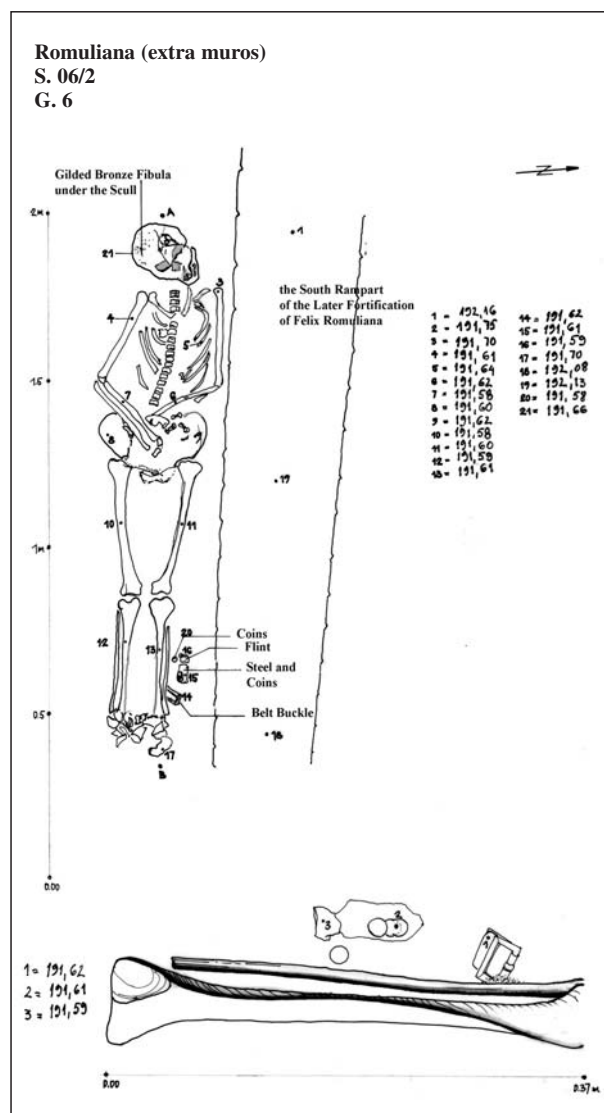

Fig. 42. Drawing of grave 6/07

Сл. 42. Црпeж грoба 6/07

⁴⁰ Documentation of the Institute of Archaeology in Belgrade and the National Museum in Zaječar.

⁴¹ From the same period, we know about *intra muros* burials in Sirmium (Popović V. 1982, 545–566, Abb. 3–8; Popović V. 1987, 119–121, Abb. 5)

⁴² In this part of the trench 1/06, the stratigraphic situation is not all that clear. In the view of G. Sommer von Bülow, wall 6 of the investigated facility was damaged by the digging of the graves 2 and 3, whereas graves 1, 4, 5 and 8 were from an earlier period than the said structure, evidence of which was the construction of wall 1 above grave 5 and the construction of wall 7 above grave 1. I believe that all the graves with inhumed individuals belonged to a period earlier than the phase of the renewed structure, and to a later period than the initial Roman construction, of which walls 3



Fig. 43. Grave goods beside the left lower leg of the deceased in situ in grave 6/06, view from the southwest

Сл. 43. Прилози уз леву појколеницу покојника in situ у гробу 6/06, са југозапада

2/06 and 3/06, and constitutes the latest III phase of the Late Roman necropolis.

As for grave 7/06, there were no elements that enable chronological attribution. Theoretically, it could date to the earliest, I or III phase of the Late Roman necropolis. Considering the elevation point of the bottom of the grave pit, the earlier dating is more probable, the end of the III – or beginning of the IV century A.D.

The section of the Late Roman necropolis, explored in 2005–2006 south of Galerius' fortified palace *Felix Romuliana* during the Serbian – German cooperation, presents the following picture regarding burials in this area:

Phase I of the Late Roman necropolis is represented by the constructed tomb in trench 05/1 and, perhaps, the cremation grave 7/06 in trench 06/1, which is dated to the end of the III – or first quarter of the IV century A.D..

Phase II of the Late Roman necropolis, consists of inhumations in pits without a structure (graves



Fig. 44. Grave goods beside the left lower leg of the deceased in situ in grave 6/06, detail from the south

Сл. 44. Прилози уз леву појколеницу покојника in situ у гробу 6/06, детаљ са југа



Fig. 45. Cruciform fibula on the right shoulder of the deceased in situ in grave 6/06 (after lifting the skull), view from the southeast

Сл. 45. Крстобразна фибула на десном рамену покојника in situ у гробу 6/06 (после подизања лобање), са југоисточа

4/06, 5/06, 6/06 and 8/06), and graves – with cysts of tegulae (graves 1/06, 2/06 and 3/06), recorded in trenches 06/1 and 06/2. The necropolis extended

and 4 were preserved, as well as the »platform«, part of the floor made of bricks bound with mortar on the outer side of the wall. In that case, the digging of grave 2a damaged wall 6, and this grave was the latest burial pit in trench 1/06.



Fig. 46. Gold-plated, cruciform fibula from grave 6/06

Сл. 46. Позлаћена крстїобразна фибула из гроба 6/06



Fig. 47. Portrait on the silver foot of a cruciform fibula from grave 6/06

Сл. 47. Портрети на сребрној стоїи крстїобразне фибуле из гроба 6/06

northwards to the fortification of *Romuliana*, as confirmed by the grave discovered next to the foundation of the southern defence wall in trench 06/2 (grave 6/06). The boundaries of the necropolis to the south and west are not clear, whereas in the east, the gully of Dragan's brook (*Draganov potok*) forms a natural boundary, on the left bank of which four graves were investigated, northeast of the fortified palace. The necropolis was dated, based on the type of grave constructions and the grave finds, to the last quarter of the IV – first half of the V century A.D.⁴³

Phase III of the necropolis consisted of a cremation grave without any finds, in trench 06/1, grave 2a/06, which, according to the stratigraphic data, belonged to a later period than the inhumation graves, and testified to the presence of »barbarians«, who practised the funerary ritual of cremation, among the inhabitants of *Romuliana* in the VI century. If the pit of grave 2 a/06 damaged wall 6 of the early Byzantine structure, one may assume that this refers to

⁴³ Petković, Ružić 2005, 129–141.

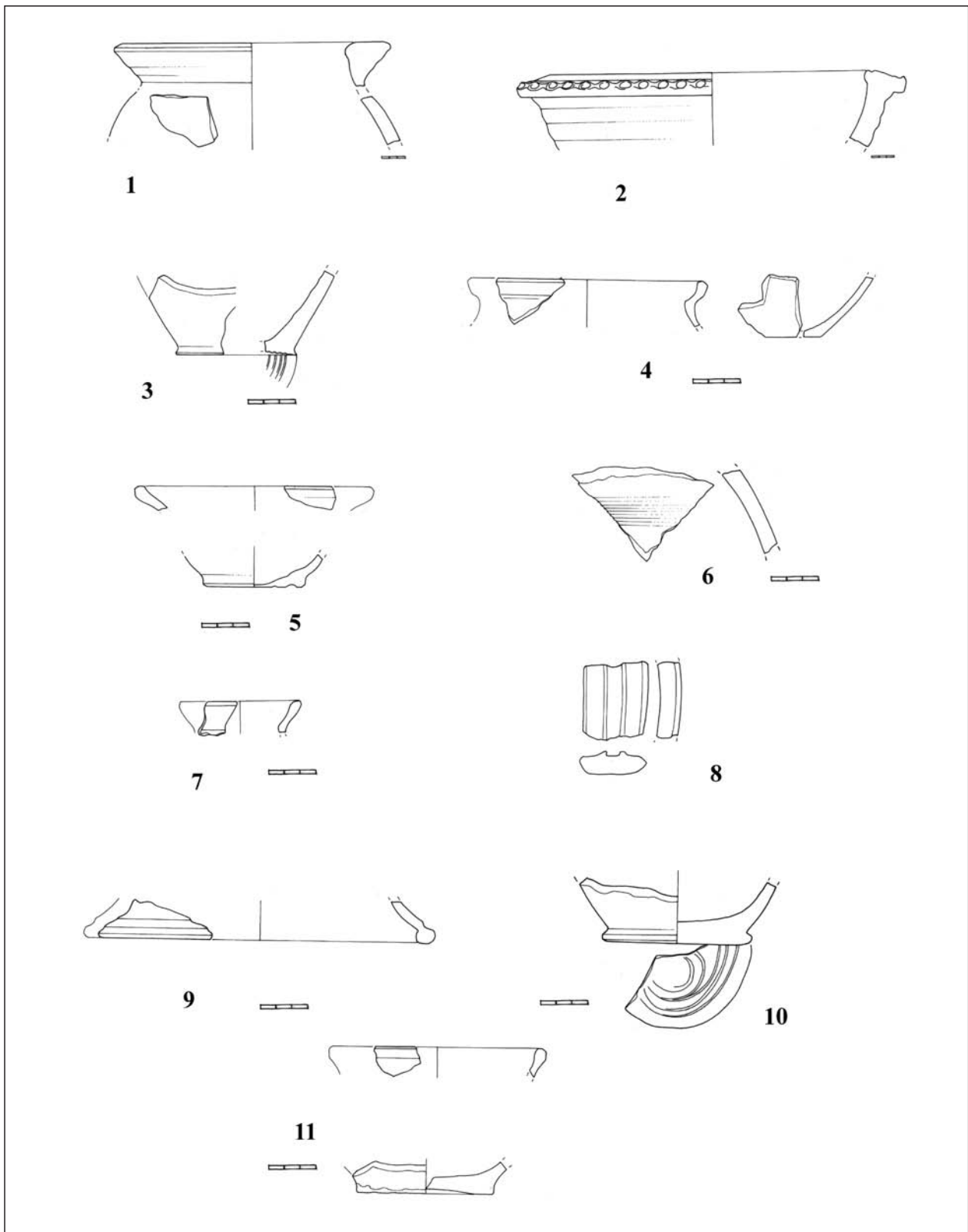

Fig. 48. Fragments of ceramic vessels from the Late Roman necropolis, south of the palace defence wall

Сл. 48. Фрагменти керамичких посуда са касноантичке некрополе јужно од београ палате

the grave of a Slav, from the end of the VI – beginning of the VII century A.D.⁴⁴

The test-pit excavations extra muros within the frame of the Serbian – German cooperation produced fresh data about the necropoles of *Romuliana*. It was established that the necropoles extended southwards, from the defence wall of the later fortifications. An earlier phase was recorded from the end of the III – the beginning of the IV century A.D, which can be linked to the period of the construction of Galerius' imperial palace, represented by the constructed tomb with the cremated remains of a high-ranking personage. The finds of the funeral monuments, and the random find of the gold torque with the pendent, belong to this necropolis. In the same area, we recorded the

necropolis of inhumations from the last quarter of the IV – first half of the V century A.D. and the grave of a cremated person, from the end of the Late Roman period, which, according to the stratigraphy of the cultural layer, can be dated from the middle of the VI to the beginning of the VII century A.D.

Considering that the Late Roman necropolis of *Romuliana* is situated on private land, which is intensely farmed, the graves are being destroyed by trench ploughing and the use of artificial fertiliser, as well as looting by »unauthorised diggers«, equipped with metal detectors. Unless the newly discovered necropolis of *Romuliana* is declared a protected area and systematically researched, we can expect it to disappear in the next few years.

⁴⁴ Slav pottery has been recorded from the last phase of the early Byzantine settlement in *Romuliana*, which indicates the presence of this ethnicity in Gamzigrad (See: Јанковић 1983 А, 130–131).

BIBLIOGRAPHY

Burns 1994 – T. C. Burns, *Barbarians within the Gates of Rome. A Study of Roman Military Policy and the Barbarians, ca. 375–425 A.D.*, Bloomington – Indianapolis.

Dimitrijević, Medović – V. Dimitrijević, A. Medović, Archaeozoological and Archaeobotanical Analysis of Grave Finds from A Tomb in S. 1/05, Romuliana, *Starinar* LVII, Beograd 2009, ???–???

Димитрова–Милчева 1980 – А. Димитрова–Милчева, *Антични теми и камеи от Националния археологически музей в София*, София

Иванов 1972 – Т. Иванов, Образите на Константин и синовете му върху луковичните фибули от България, *Археология*/1972, 4, 9–29.

Јанковић 1983 – Ђ. Јанковић, У сутону антике, in: *Гамзиград. Касноантички царски дворац*, Галерија САНУ, Београд, 98–119.

Јанковић 1983 А – Ђ. Јанковић, Рановизантијски Гамзиград, in: *Гамзиград. Касноантички царски дворац*, Галерија САНУ, Београд, 120–141.

Јовановић 1975 – А. Јовановић, О проблему фибула са портретима, *ЗРФФ XIII*, I, Београд, 43–51.

Keller 1971 – Keller, E. *Die spätrömischen Gräbfunde in Südbayern*, MBV 14, München.

Јаловић 1983 – А. Јаловић, Епиграфски споменици, in: *Гамзиград. Касноантички царски дворац*, Галерија САНУ, Београд, 163–177.

Laur – Belaart 1959 – R. Laur – Belaart, Ein frühchristliche Grab aus Bazel, *Ur – Schweiz* 23/4, 1959, 57–71.

Mirković 1997 – M. Mirković, Romuliana, the Roman Army and Soldiers, in: *Antidoron Dragoslavo Srejić completis annis LXV ab amicis, collegis, discipulis oblatum*, ed. M. Lazić, Beograd

Petrović 1995 – P. Petrović, *Timacum Minus – Romuliana*, IMS III-2, Beograd.

Petković 2006 – S. Petković, Study of Stratigraphy of Cultural Layers of Late Roman Romuliana; Case Study: South Tower of West Gate of Later Fortification, in: *Felix Romuliana. 50 Years of Archaeological Excavations, Papers from the International Conference, Zaječar, 27th–29th October 2003*, ed: Vasić, M., Beograd: Institute of Archaeology, Committee on Archaeology of Serbian Academy of Sciences and Arts, National Museum Zaječar, 29–45.

Petković, Ružić 2005 – S. Petković, M. Ružić, Roman Necropolis, in. S. Petković, M. Ružić, S. Jo-

vanović, M. Vuksan, Zs. Zoffmann, *Roman and Medieval Necropolis in Ravna near Knjaževac*, Archaeological Institute, Monographs No. 42, Beograd, 23–176.

Поповић И. 1991 – И. Поповић, Римске камеје из Народног музеја у Пожаревцу, *Viminacium* 6, Пожаревац, 53–68.

Поповић И. 1996 – И. Поповић, Римски накити у Народног музеју у Београду. II Златан накити, Београд

Поповић И. 2001 – И. Поповић, Касноантички и рановизантијски накити од злата у Народног музеју у Београду, Београд.

Поповић V. 1982 – V. Popović, Desintegration und Ruralisation der Stadt im Ost – Illyricum vom 5. bis 7. Jahrhundert n. Chr., in: *Palast und Hütte. Beiträge zum Bauen und Wohnen im Altertum* Berlin, 25–30. November 1979, Mainz, 545–566.

Поповић V. 1987 – V. Popović, Die Süddanubischen Provinzen in der in der Spätantike vom Ende des 4. bis zur Mitte des 5. Jahrhunderts, in: *Die Völker Südosteuropas im 6. bis 8. Jahrhunderts*, Hrsg. Hänsel, B., München – Berlin, 95–139.

Pröttel 1988 – Ph. M. Pröttel, Zur Chronologie der Zwiebelknopffibeln, *JRGZM* 35, 1/1988, 347–372.

Sommer von Bülow, Schüler 2009 – G. Sommer von Bülow, T. Schüler, Geophysical and Archaeological Research in Gamzigrad – Report on Campaigns 2004–2007, *extra muros, Starinar* LVII, Beograd 2009, 231–249.

Срејовић 1983 – Срејовић, Д. Царски дворац, in: *Гамзиград. Касноантички царски дворац*, Галерија САНУ, Београд, 24–95.

Tomović et al. 2004 – M. Tomović, I. Popović, B. Borić-Brešković, T. Cvjetičanin, S. Stefanović, A. V. Popović, *Šarkamen (Eastern Serbia). A Tetrarchic Imperial Palace – the Memorial Complex*, Archaeological Institute, Monographs No. 45, Beograd.

Vágó, Bóna 1976

E.B. Vágó, I. Bóna, *Die Gräberfelder von Intercisa I. Der spätrömische Südstadtfriedhof*, Budapest.

Vasić 2009 – M. Vasić, Findings of Coins from Romuliana, Unearthed in 2005 and 2006 outside the Fortified Palace, *Starinar* LVII, Beograd 2009, 309–314.

Živić 2009 – M. Živić, Catalogue of Small Finds from Excavations outside the Fortified Palace of Romuliana (2005–2007), *Starinar* LVII, Beograd 2009, 277–307.

Резиме:

СОФИЈА ПЕТКОВИЋ,
Археолошки институт, Београд

**КАСНОАНТИЧКА НЕКРОПОЛА РОМУЛИЈАНЕ
ПРОСТОР ЈУЖНО ОД УТВРЂЕНЕ ПАЛАТЕ
(ИСТРАЖИВАЊА 2005–2006)**

Истраживања 2004–2007. у оквиру међународне сарадње са Римско – германском комисијом Немачког археолошког института у Франкфурту имала су за циљ испитивање локалитета Гамзиград – *Romuliana* на простору *extra muros* геофизичким методама и археолошким сондажним ископавањима. На основу геофизичке проспекције, 2005–2006. године вршена су верификациона ископавања јужно од утврђене царске палате *Felix Romuliana*, којима је делом истражена касноантичка некропола Ромулијане: 1. 2005. године истражена је зидана гробница квадратне основе у којој су, у централном гробу са тумулоидном конструкцијом, сахрањени остаци спаљеног покојника

са војном опремом коњаника и златном крстобразном фибулом, датована новцем Клаудија II и Проба, као и поменути налази у крај III – почетак IV века; 2. 2006. године у сонди 06/1, констатована је некропола од шест инхумираних и два кремирана покојника, која се на основу стратиграфије, типа гробних конструкција и налаза, може датовати у старију фазу краја IV – прве половине V века и млађу, друге половине VI века; 3. у сонди 06/2, уз темељ јужног бедема Ромулијане, констатована је инхумација покојника високог војног ранга краја IV века, датована новцем цара Валенса из 375–378. год. и позлаћеном крстобразном фибулом са царским портретима.